

STIERACIE KRÚŽKY

Príklady aplikácie stieracích krúžkov

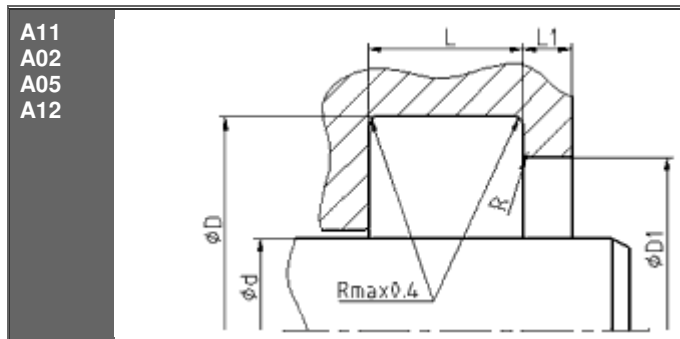

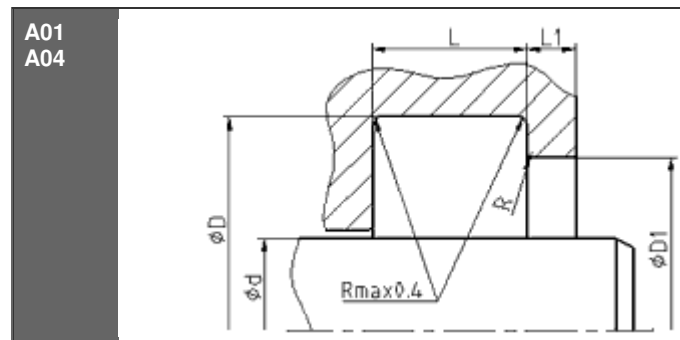

V prípade nejasností pri aplikácii stieracích krúžkov, Vám pomôžeme nájsť najoptimálnejšie riešenie.

	A01		teplota	max. rýchlosť	materiál
		<p>Jednočinný stierací krúžok, zaisťujúca pevné usadenie v drážke, stieracia hrana spoľahlivo chráni prenikaniu nečistoty a prachu. Zabezpečuje spätný tok zostatkovej olejovej vrstvy..</p>	-30 °C ... +110 °C	4 m/s	ECOPUR
			-20 °C ... +110 °C	4 m/s	H-ECOPUR
			-50 °C ... +110 °C	4 m/s	T-ECOPUR
			-20 °C ... +110 °C	5 m/s	S-ECOPUR
			-30 °C ... +110 °C	4 m/s	G-ECOPUR
			-30 °C ... +100 °C	4 m/s	ECORUBBER 1
			-25 °C ... +150 °C	4 m/s	ECORUBBER-H
			-20 °C ... +200 °C	4 m/s	ECORUBBER 2
			-50 °C ... +150 °C	4 m/s	ECORUBBER 3

	A02		teplota	max. rýchlosť	materiál
		<p>Jednočinný stierací krúžok, zaisťujúca pevné usadenie v drážke, stieracia hrana spoľahlivo chráni prenikaniu nečistoty a prachu. Zabezpečuje spätný tok zostatkovej olejovej vrstvy..</p>	-30 °C ... +110 °C	4 m/s	ECOPUR
			-20 °C ... +110 °C	4 m/s	H-ECOPUR
			-50 °C ... +110 °C	4 m/s	T-ECOPUR
			-20 °C ... +110 °C	5 m/s	S-ECOPUR
			-30 °C ... +110 °C	4 m/s	G-ECOPUR
			-30 °C ... +100 °C	4 m/s	ECORUBBER 1
			-25 °C ... +150 °C	4 m/s	ECORUBBER-H
			-20 °C ... +200 °C	4 m/s	ECORUBBER 2
			-50 °C ... +150 °C	4 m/s	ECORUBBER 3

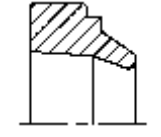
	A03		teplota	max. rýchlosť	materiál
		Jednočinný stierací krúžok s pevnou kľetkou pre nalisovani do otvorených usadení , stieracia hrana spoľahlivo chráni prenikaniu nečistoty a prachu Zabezpečuje spätný tok zostatkovej olejovej vrstvy.	-30 °C ... +80 °C -20 °C ... +80 °C -50 °C ... +80 °C -40 °C ... +80 °C -20 °C ... +80 °C -30 °C ... +80 °C -30 °C ... +80 °C -50 °C ... +80 °C -25 °C ... +150 °C -20 °C ... +200 °C	4 m/s 4 m/s 4 m/s 4 m/s 5 m/s 4 m/s 4 m/s 4 m/s 4 m/s 4 m/s	Wiping part ECOPUR H-ECOPUR T-ECOPUR T-ECOPUR S-ECOPUR G-ECOPUR ECORUBBER 1 ECORUBBER 3 ECORUBBER-H ECORUBBER 2 Housing ECOTAL/ECOMID ECOTAL/ECOMID ECOTAL ECOMID ECOTAL/ECOMID ECOTAL/ECOMID ECOTAL/ECOMID ECOTAL/ECOMID ECOTAL/ECOMID ECOPEAK ECOPEAK

	A04		teplota	max. rýchlosť	materiál
		Jednočinný pneumatický stierací krúžok, zaisťuje pevné usadenie v drážke, stieracia hrana spoľahlivo chráni prenikaniu nečistoty a prachu. Zabezpečuje zachovanie pôvodnej olejovej vrstvy..	-30 °C ... +110 °C -20 °C ... +110 °C -50 °C ... +110 °C -20 °C ... +110 °C -30 °C ... +110 °C -30 °C ... +80 °C -25 °C ... +150 °C -20 °C ... +200 °C -50 °C ... +150 °C	4 m/s 4 m/s 4 m/s 5 m/s 4 m/s 4 m/s 4 m/s 4 m/s 4 m/s	ECOPUR H-ECOPUR T-ECOPUR S-ECOPUR G-ECOPUR ECORUBBER 1 ECORUBBER-H ECORUBBER 2 ECORUBBER 3

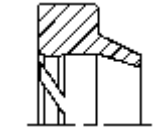
	A05-A		teplota	max. rýchlosť	materiál
		Jednočinný pneumatický stierací krúžok	-30 °C ... +110 °C -20 °C ... +110 °C -50 °C ... +110 °C -20 °C ... +110 °C -30 °C ... +110 °C -30 °C ... +100 °C -25 °C ... +150 °C -20 °C ... +200 °C -50 °C ... +150 °C	4 m/s 4 m/s 4 m/s 5 m/s 4 m/s 4 m/s 4 m/s 4 m/s 4 m/s	ECOPUR H-ECOPUR T-ECOPUR S-ECOPUR G-ECOPUR ECORUBBER 1 ECORUBBER-H ECORUBBER 2 ECORUBBER 3

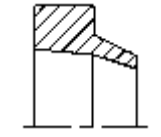
	A05-B		teplota	max. rýchlosť	materiál
		Jednočinný pneumatický stierací krúžok	-30 °C ... +110 °C -20 °C ... +110 °C -50 °C ... +110 °C -20 °C ... +110 °C -30 °C ... +110 °C -30 °C ... +100 °C -25 °C ... +150 °C -20 °C ... +200 °C -50 °C ... +150 °C	4 m/s 4 m/s 4 m/s 5 m/s 4 m/s 4 m/s 4 m/s 4 m/s 4 m/s	ECOPUR H-ECOPUR T-ECOPUR S-ECOPUR G-ECOPUR ECORUBBER 1 ECORUBBER-H ECORUBBER 2 ECORUBBER 3

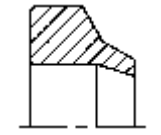
	A07-A		teplota	max. rýchlosť	materiál
		Špeciálny stierací krúžok, používaný v anglických zariadeniach.	-30 °C ... +110 °C -20 °C ... +110 °C -50 °C ... +110 °C -20 °C ... +110 °C -30 °C ... +110 °C -30 °C ... +100 °C -25 °C ... +150 °C -20 °C ... +200 °C -50 °C ... +150 °C	4 m/s 4 m/s 4 m/s 5 m/s 4 m/s 4 m/s 4 m/s 4 m/s 4 m/s	ECOPUR H-ECOPUR T-ECOPUR S-ECOPUR G-ECOPUR ECORUBBER 1 ECORUBBER-H ECORUBBER 2 ECORUBBER 3

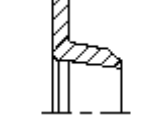
	A08		teplota	max. rýchlosť	materiál
		Sterací krúžok používaný namä v starších pneumatických a hydraulických zariadeniach.	-30 °C ... +110 °C -20 °C ... +110 °C -50 °C ... +110 °C -20 °C ... +110 °C -30 °C ... +110 °C -30 °C ... +100 °C -25 °C ... +150 °C -20 °C ... +200 °C -50 °C ... +150 °C	4 m/s 4 m/s 4 m/s 5 m/s 4 m/s 4 m/s 4 m/s 4 m/s 4 m/s	ECOPUR H-ECOPUR T-ECOPUR S-ECOPUR G-ECOPUR ECORUBBER 1 ECORUBBER-H ECORUBBER 2 ECORUBBER 3

	A10-A		teplota	max. rýchlosť	materiál
		Sterací krúžok používaný na zariadeniach v USA.	-30 °C ... +110 °C -20 °C ... +110 °C -50 °C ... +110 °C -20 °C ... +110 °C -30 °C ... +110 °C -30 °C ... +100 °C -25 °C ... +150 °C -20 °C ... +200 °C -50 °C ... +150 °C	4 m/s 4 m/s 4 m/s 5 m/s 4 m/s 4 m/s 4 m/s 4 m/s 4 m/s	ECOPUR H-ECOPUR T-ECOPUR S-ECOPUR G-ECOPUR ECORUBBER 1 ECORUBBER-H ECORUBBER 2 ECORUBBER 3

	A11		teplota	max. rýchlosť	materiál
		Hydraulický/pneumatický sterací krúžok používaný v spojení s PTFE tesneniami alebo samostatne pri pneumatických aplikáciách.	-30 °C ... +110 °C -20 °C ... +110 °C -50 °C ... +110 °C -20 °C ... +110 °C -30 °C ... +110 °C -30 °C ... +100 °C -25 °C ... +150 °C -20 °C ... +200 °C -50 °C ... +150 °C	1 m/s 1 m/s 1 m/s 1 m/s 1 m/s 1 m/s 1 m/s 1 m/s 1 m/s	ECOPUR H-ECOPUR T-ECOPUR S-ECOPUR G-ECOPUR ECORUBBER 1 ECORUBBER-H ECORUBBER 2 ECORUBBER 3

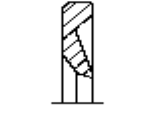
	A13-A		teplota	max. rýchlosť	materiál
		Stirací krúžok s tvrdých plastov do silno znečisteného prostredia, ktorý chráni elastomerové časti proti poškodeniu.	-50 °C ... +80 °C -40 °C ... +80 °C -50 °C ... +260 °C	1 m/s 1 m/s 1 m/s	ECOTAL ECOMID ECOPEAK

	A25-F		teplota	max. rýchlosť	materiál
		PTFE sterací krúžok s predpätým O-krúžkom má dobré vlastnosti pri suchom chode bez trhania a v spojení s vhodným materiálom aj výbornú tepelnú odolnosť.	-30 °C ... +100 °C -20 °C ... +200 °C -30 °C ... +100 °C -20 °C ... +200 °C -30 °C ... +100 °C -20 °C ... +200 °C	4 m/s 4 m/s 4 m/s 4 m/s 4 m/s 4 m/s	glide ring ECOFLO 2 ECOFLO 2 ECOFLO 3 ECOFLO 3 ECOFLO 4 ECOFLO 4 Energizer NBR (70 Shore A) FPM (75 Shore A) NBR (70 Shore A) FPM (75 Shore A) NBR (70 Shore A) FPM (75 Shore A)

	A26-F		teplota	max. rýchlosť	materiál
		Dvojčinný PTFE sterací krúžok s predpätým O-krúžkom má dobré vlastnosti pri suchom chode bez trhania a v spojení s vhodným materiálom aj výbornú tepelnú odolnosť. Tandemové použitie s tesnením S09.	-30 °C ... +100 °C -20 °C ... +200 °C -30 °C ... +100 °C -20 °C ... +200 °C -30 °C ... +100 °C -20 °C ... +200 °C	4 m/s 4 m/s 4 m/s 4 m/s 4 m/s 4 m/s	glide ring ECOFLO 2 ECOFLO 2 ECOFLO 3 ECOFLO 3 ECOFLO 4 ECOFLO 4 Energizer NBR (70 Shore A) FPM (75 Shore A) NBR (70 Shore A) FPM (75 Shore A) NBR (70 Shore A) FPM (75 Shore A)

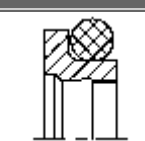
	A27-F		teplota	max. rýchlosť	materiál
		Dvojčinný PTFE sterací krúžok s predpätým O-krúžkom má dobré vlastnosti pri suchom chode bez trhania a v spojení s vhodným materiálom aj výbornú tepelnú odolnosť. Tandemové použitie s tesnením S09.	-30 °C ... +100 °C -20 °C ... +200 °C -30 °C ... +100 °C -20 °C ... +200 °C -30 °C ... +100 °C -20 °C ... +200 °C	4 m/s 4 m/s 4 m/s 4 m/s 4 m/s 4 m/s	glide ring ECOFLO 2 ECOFLO 2 ECOFLO 3 ECOFLO 3 ECOFLO 4 ECOFLO 4 Energizer NBR (70 Shore A) FPM (75 Shore A) NBR (70 Shore A) FPM (75 Shore A) NBR (70 Shore A) FPM (75 Shore A)